

Wireless Video Door Phone

USER GUIDE



KIVOS

Wireless Video Door Phone

USER GUIDE

【KDB300】

www.kivos.com.cn

Fashion • Technology • Taste

Enjoy Intelligent Life

The wireless peephole video door phone is a 2.4G wireless high-tech household intelligent product integrating doorbell, photo-taking, intercom, monitor and unlocking functions into one. Especially is its unique human body detection function, when visitor is in its detection range, the indoor monitor shall be activated, show the image of the outdoor on its screen and take photo automatically. Therefore, even you were not at home, you also could know who visited you. This model is the guarantee for your home security.

This product does not use wires. It is convenient to install and simple to use. It's specially designed for villas. A outdoor unit can work with three matched handsets with max. working distance 300 meters in an open area.

Adopting the latest energy saving technology, its stable performance and fashionable appearance design make it the first choice of your high-quality intelligent life.



Fashion • Technology • Taste

Enjoy Intelligent Life — “KIVOS”

“KIVOS” is dedicating to equipping modern fashion life with high-tech products, its KDB300 wireless video door phone is a 2.4G wireless high-tech household intelligent product integrating doorbell, photo-taking, video-recording, intercom, monitor and unlocking functions into one. Adopting the latest energy saving technology, its stable performance and fashionable appearance design make it the first choice of your high-quality intelligent life.

This product is convenient to install, and simple to use. It is specifically designed for villa users and supporting the use of two outdoor units and three indoor monitors. Indoor monitors can communicate to each other, communication range can reach 300 meters in open space. Battery equipped outdoor unit's proper monitoring function can replace Baby Monitor.



Table of Contents

Introduction	1
Safety Warnings & Attentions	1
Product Overview	3
Product Diagram	6
Installation Guide	8
Installation Step	8
Attention During Installation	9
Battery Installation	9
Functions & Application	10
Outdoor Unit Starting Up	10
Indoor Monitor Starting Up	10
Night-Vision	11
Date & Time Setting	11
Ringng Setting	11
Lock delay Setting	11
PIR Setting	12
Outdoor Unit CALL Handset	12
Indoor Monitor CALL Outdoor Unit(Monitor)	13
Exposure Adjustment	13
Photo-preview deletion	14
Battery & charge	14
Configuration	15
Statement	15
General faults and solutions	16

FC Changes or modifications not expressly approved by the party responsible for compliance could void the user's authority to operate the equipment. This equipment has been tested and found to comply with the limits for a Class B digital device, pursuant to Part 15 of the FCC Rules. These limits are designed to provide reasonable protection against harmful interference in a residential installation. This equipment generates uses and can radiate radio frequency energy and, if not installed and used in accordance with the instructions, may cause harmful interference to radio communications. However, there is no guarantee that interference will not occur in a particular installation. If this equipment does cause harmful interference to radio or television reception, which can be determined by turning the equipment off and on, the user is encouraged to try to correct the interference by one or more of the following measures:

- Reorient or relocate the receiving antenna.
- Increase the separation between the equipment and receiver.
- Connect the equipment into an outlet on a circuit different from that to which the receiver is connected.
- Consult the dealer or an experienced radio/TV technician for help.

Introduction

Thank you for choosing this wireless video door phone. Please read this Manual carefully to fully understand its usage, perfect functions and simple operation.

The company reserves the right to modify this Manual from time to time without prior notice.

Safety Warning & Attention

1. Attention

- Do not place this product on an uneven or unstable table-board to prevent failure or damage caused by falling.
- Only the battery and charger designated by the Company can be used on this product. Application of other products may lead to leakage, overheating, blowout and fire of the battery.
- Do not violently strike, shake or toss the wireless video door phone to prevent failure and fire caused to the wireless video door phone.
- Do not put battery, charger or wireless video door phone in the microwave oven or high-pressure device; otherwise, damage and fire of electrical circuit and other accidents may be caused.
- Do not use this product in a place with flammable and explosive gas; otherwise, amount of dust; otherwise, product failure may be caused.

2. Attention for operation of this product

- Do not apply force on LCD screen or knock other objects with it, otherwise, breakage and damage of LCD panel and seepage of crystalline liquid will be caused. If the crystalline liquid enters your eyes, there will be danger of ablepsia. Wash your eyes (be sure not rub your eyes) and go to see the doctor immediately.
- Do not dismantle or remodel this product, otherwise, damage, creepage and electrical fault may be caused to this product.
- Do not press the keys with a pin, stump of pen/pencil and other keen-edged objects; otherwise, damage or mis-operation will be

①

caused.

- Place tiny metal objects such as drawing pin at a place far away from the speaker. As the speaker has magnetic property while working, it will attract these tiny metal objects, which may lead to personal injuries or damage of the speaker.
- Do not press the terminal of lens at strong light source, such as the sun; otherwise, damage of the image sensor may be caused.
- Do not press the terminal of lens with much force; otherwise, personal injury or damage of the device may be caused.

3. Attention for operation of charger

You may charge the device with a charger or through a USB data line connected to the computer.

Charge with matched alternate current; creepage, fire and damage of the door phone and charger may be caused if other voltage is used.

It is forbidden to short circuit the charge, otherwise, electrical shock, smoke and damage of the charger will be caused.

- Do not use the charger at the time when the power cord is damaged, otherwise, fire and electrical shock will be caused.
- Clear away the dust accumulated on power outlet ASAP. Do not place a vessel used to retain water beside the charger to prevent overheating, creepage and failure of charger caused by spilling water.
- If the charger is in contact with water or other liquids, disconnect the power supply immediately to prevent overheating, fire electrical shock and failure of the charger.
- Do not dismantle or remodel this product, otherwise, damage, creepage and electrical fault may be caused to this product.
- Do not use the charger in places with high humidity such as bathroom, otherwise, electric shock, fire and damage of the charger will be caused.
- Do not touch the charger, electrical line and power outlet with wet hand(s), otherwise, electric shock may be caused.
- Do not place heavy objects on the electrical line or refit the electrical line, otherwise, electric shock and fire will be caused.
- Before cleaning and maintenance, first pull the plug off the power

②

Introduction	1
Safety Warning & Attentions	1
Product Overview	3
Product Diagram.....	6
Installation Guide.....	8
Installation Steps.....	8
Attentions During Installation	10
Battery Installation	10
Installation of Storage Card	11
Storage Card Introduction	11
Functions & Application	12
Outdoor Unit Starting Up	12
Indoor Monitor Starting up	12
Outdoor Unit CALL Indoor Monitor	13
Indoor Monitor CALL Outdoor unit (Monitoring)	13
Indoor Monitor CALL Indoor Monitor (Intercom)	14
Night-Vision	15
Exposure Adjustment	15
Tamper Alarm Function	15
USB Functions	16
Indoor Monitor Menus	16
Video	16
Photo	17
Call History	17
Code	18
Setting	20
Battery & Charge	22
Configuration	23
Statement	23

Introduction

Thank you for choosing this wireless video door phone. Please read this Manual carefully to fully understand its usage, perfect functions and simple operation.

Before using this product, please read these Attentions carefully to ensure safe and proper operation of this product.

The Company reserves the right to modify this Manual from time to time without prior notice.

Safety Warning & Attentions

1. Attentions

- Do not place this product on an uneven or unstable table-board to prevent failure or damage caused by falling.
- Only the battery and charger designated by the Company can be used on this product. Application of other products may lead to leakage, overheating, blowout and fire of the battery.
- Do not violently strike, shake or toss the wireless video door phone to prevent failure and fire caused to the wireless video door phone.
- Do not put battery, charger or wireless video door phone in the microwave oven or high-pressure device; otherwise, damage and fire of electrical circuit and other accidents may be caused.
- Do not use this product in a place with flammable and explosive gas; otherwise, product failure and fire may be caused.
- Do not place this product in a place with high temperature, high humidity or large amount of dust; otherwise, product failure may be caused.

2. Attentions for operation of this product

- Do not apply force on LCD screen or knock other objects with it, otherwise, breakage and damage of LCD panel and seepage of crystalline liquid will be caused. If the crystalline liquid enters your eyes, there will be danger of ablepsia. Wash your eyes (be sure not to rub your eyes) and go to see a doctor immediately.
- Do not dismantle or remodel this product, otherwise, damage, creepage and electrical fault may be caused to this product.

①

outlet.

- Grasp the charger while pulling off the plug, as pulling the electrical line will lead to damage of electrical line, electric shock and fire.

4. Operation and maintenance

- Please keep this product dry, as rainwater, moisture, humidity and liquids or moisture content may contain mineral matters that erode the circuit.
- Do not keep this product in any place with high temperature. As high temperature may shorten the lifespan of electronic device, damage the battery and cause deformation or melting of certain plastic parts and components.
- Do not keep this product in any place with low temperature. As when being moved from a place with low temperature to a place with normal temperature, it may generate humidity inside, which may cause damage of circuit board.
- Do not attempt to dismantle this product. As improper handling by nonprofessional personnel may cause damage of the device.
- Do not toss, knock or shake this product, as tough operation mode may damage the motherboard inside the device.
- If this product is made wet by mistake, shut it down, remove the battery, and restart the product after confirming it complete dry after 24 hours.
- Do not have the metal parts (specially configured interfaces of charger and data line excluded) in contact with charger interface to avoid short circuit.
Use clean and dry soft cloth to clean the lens, infrared lamp and light sensor.

! Warning: improper operation will void warranty!

Product Overview

— Characteristics and application:

1. Fashion appearance — adopt European design, full of modern science and technology feeling, suitable for houses of various decorative styles.

③

- Do not press the keys with a pin, stump of pen/pencil and other keen-edged objects; otherwise, damage or mis-operation will be caused.
 - Place tiny metal objects such as drawing pin at a place far away from the speaker. As the speaker has magnetic property while working, it will attract these tiny metal objects, which may lead to personal injuries or damage of the speaker.
 - Do not project the lens at strong light source, such as the sun; otherwise, damage of the image sensor may be caused.
 - Do not press the terminal of lens with much force; otherwise, personal injury or damage of the device may be caused.
- #### 3. Attentions for operation of charger
- You may charge the device with a charger or through a USB data line connected to the computer.
 - Charge with matched alternate current; creepage, fire and damage of the door phone and charger may be caused if other voltage is used.
 - It is forbidden to short circuit the charger, otherwise, electrical shock, smoke and damage of the charger will be caused.
 - Do not use the charger at the time when the power cord is damaged, otherwise, fire and electrical shock will be caused.
 - Clear away the dust accumulated on power outlet ASAP.
 - Do not place a vessel used to retain water beside the charger to prevent overheating, creepage and failure of charger caused by spilling water.
 - If the charger is in contact with water or other liquids, disconnect the power supply immediately to prevent overheating, fire, electrical shock and failure of the charger.
 - Do not dismantle or remodel the charger, otherwise, personal injury, electric shock, fire and damage of charger may be caused.
 - Do not use the charger in places with high humidity such as bathroom, otherwise, electric shock, fire and damage of the charger will be caused.
 - Do not touch the charger, electrical line and power outlet with wet hand(s), otherwise, electric shock may be caused.
 - Do not place heavy objects on the electrical line or refit the electrical line, otherwise, electric shock and fire will be caused.
 - Before cleaning and maintenance, first pull the plug off the power outlet.
 - Grasp the charger while pulling off the plug, as pulling the electrical line will lead to damage of electrical line, electric shock and fire.

4. Operation and maintenance

- Please keep this product dry, as rainwater, moisture, humidity and liquids or moisture content may contain mineral matters that erode the circuit.
- Do not keep this product in any place with high temperature. As high temperature may shorten the life span of electronic device, damage the battery and cause

②

2. Hidden antenna — adopt built-in antenna design, protect the antenna effectively.

3. Extra large range of vision — an extra wide angle viewable.

4. High-resolution color LCD screen — adopt 3.5-inch mainstream TFT digital LCD screen, achieve outstanding clarity.

5. High-resolution digital camera — adopt 300,000 pixels digital camera, image focusing vivid and clear.

6. High speed transmission — image transmission speed is 25fps, the image is clear and fluent.

7. Infrared Night-Vision — under the environment of insufficient outdoor light, the handset can activate the infrared Night-Vision to clearly display and record the outdoor scenes.

8. 12 kinds of ringtones — users can select the desired doorbells ringtones freely

9. One-key display — simple and convenient to use, view the outdoor scenes and take photos just by pressing down one key.

10. Auto detection — it would auto take photo when a visitor come close to the door.

11. Intercom function — can choose one-way or both-way talkback function.

12. Super long standby — high capacity rechargeable lithium batteries are provided, adopt intelligent energy-saving technology, fully charged batteries service time could be up to 40days.

13. Charge-and-record supported — without the need to worry that the operation will be affected due to depletion of electrical quantity.

14. Auto circulating memory — 100 photos auto circulating stored.

15. USB data charging wire — charge through the USB interface.

16. Multifunction holder — matching charger.

17. Multimachine extended function — support one outdoor units and three handsets at most.

18. Long distance transmission — communication distance can reach 300 meters in open space.

19. Frequency range — adopt 2.4G ISM digital public frequency range: 2402~2483.5MHz

20. Adaptive frequency hopping technique — adopt AFH (Adaptive Frequency Hopping Technique), produce communication frequency and Auto-Sync frequency randomly.

④

deformation or melting of certain plastic parts and components.

- Do not keep this product in any place with low temperature. As when being moved from a place with low temperature to a place with normal temperature, it may generate humidity inside, which may cause damage of circuit board.
- Do not attempt to dismantle this product. As improper handling by nonprofessional personnel may cause damage of the device.
- Do not toss, knock or shake this product, as tough operation mode may damage the motherboard inside the device.
- If this product is made wet by mistake, shut it down, remove the battery, and restart the product after confirming it complete dry after 24 hours.
- Do not have the metal parts (specially configured interfaces of charger and data line excluded) in contact with charger interface to avoid short circuit.
- Use clean and dry soft cloth to clean the lens, infrared lamp and light sensor.

! Warning: improper operation will void warranty! !

Product Overview

Model: KDB300

Characteristics and application:

1. Fashion appearance - adopt European design, full of modern science and technology feeling, suitable for houses of various decorative styles.
2. Hidden antenna - adopt built-in antenna design, protect the antenna effectively.
3. Extra large range of vision - an extra wide angle viewable.
4. High-resolution color LCD screen - adopt 3.5-inch mainstream TFT digital LCD screen, achieve outstanding clarity.
5. High-resolution digital camera - adopt 300,000 pixels digital camera, image focusing vivid and clear.
6. Infrared Night-Vision - under the environment of insufficient outdoor light, the indoor monitor can activate the infrared Night-Vision to clearly display and record the outdoor scenes.
7. LED fill-in light function - same to 5, show colorful effect .
8. 12 kinds of ringtones - users can select the desired doorbells freely
9. One-key display - simple and convenient to use, view the outdoor scenes and take photos or record videos under manual or automatic mode just by pressing down one key.
10. Intercom function - can choose one-way or both-way talkback function.
11. Support extended IF memory - up to 4G, photo/video is stored in T-flash storage card.
12. Super long standby - high capacity rechargeable lithium batteries are provided, adopt intelligent energy-saving technology, fully charged batteries provide up to 40 days of runtime.

③

二、Performance parameters:

Outdoor unit	Power	Specific lithium battery BP-6M(1100mAh)
	Consumption	400mA
	Outline dimension	134*74*31mm
	Weight	122g
	Environmental condition	Temperature: -10℃~+50℃
	Waterproof grade	IP55
	Placement	Hang on outwall
	Surface material	ABS & hardware accessories
	Camera	300,000pixels
	View angle	120° wide angle
	Night vision pattern	Infrared lamps
	PIR	3M*100°
	Working time	3 hours continuously
	Standby time	300hours
Charge time	3hours	
External power	DC5V 1A	
Indoor monitor	Power	Specific lithium battery BP-6M(1100mAh)
	Consumption	400mA
	Outline dimension	126*84*20mm
	Weight	110g
	Environmental condition	Temperature: -0℃~+40℃
	Placement	table style (handheld)
	LCD size	3.5" TFT color screen
	Wireless communication mode	2.4GHz
	Images spread	25fps
	Picture format	JPEG
	Working time	4hours continuously
	Standby time	500hours
	Charge time	3hours
	External power	DC5V 1A
Application distance	About 300m in open space	

5

Product diagram

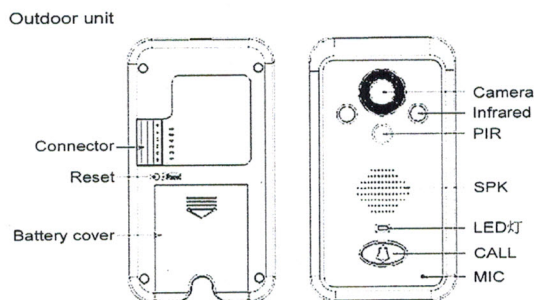

Indoor monitor

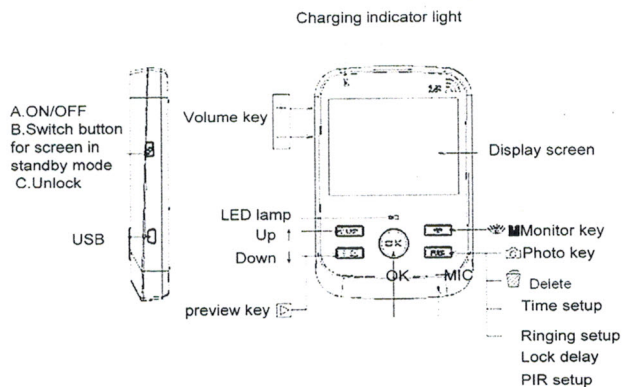

6

13. Charge-and-record supported - without the need to worry that the operation will be affected due to depletion of electrical quantity.
14. Auto circulating memory - without the need to worry that real-time recording is unachievable due to insufficient space of storage card.
15. USB data charging wire - charge, downloading or uploading audio-visual materials can be realized through the USB interface.
16. Multifunction holder - wall-hung type or table type provided.
17. Multimachine extended function - support two outdoor units and three indoor monitor at most.
18. Long distance transmission - communication distance can reach 300 meters in open space.
19. Frequency range - adopt 2.4G ISM digital public frequency range:2402~2483.5MHz
20. Adaptive frequency hopping technique - adopt AFH (Adaptive Frequency Hopping Technique), produce communication frequency and Auto-Sync frequency randomly.

Performance parameters:

Outdoor unit	Power	Specific lithium battery BP-6M(1100mAh)
	Consumption	400mA
	Outline dimension	134*74*31mm
	Weight	122g
	Environmental condition	Temperature: -10℃~+50℃
	Waterproof grade	IP55
	Placement	Hang on outwall
	Surface material	ABS & hardware accessories
	Camera	300,000pixels
	View angle	120° wide angle
	Night vision pattern	2 leds or IR lamp
	Working time	3hours continuously
	Standby time	1000hours
	Charge time	3hours
External power	DC5V 1A	

4

Indoor monitor	Power	Specific lithium battery BP-6M(1100mAh)
	Consumption	400mA
	Outline dimension	126*84*20mm
	Weight	110g
	Environmental condition	Temperature: -0℃~+40℃
	Placement	Wall hung type or table style
	LCD size	3.5" TFT color screen
	Wireless communication mode	2.4GHz
	Working time	2hours continuously
	Standby time	100hours
	Charge time	3hours
	External power	DC5V 1A
	Application distance	About 300m in open space

5

Table type charging station for handset:



Key introduction:

A. Handset Keys (7pcs Key) :

1. (**OK key**) : work as a off-hook key and a on-hook key; as a speaking key.
2. (**↑ UP key**) : as an adjustment key for choosing.
3. (**↓ DOWN/ [Preview]** key) : as an adjustment key for choosing when long press it; as a preview key when short press it.
4. (**[Monitor]** key) : work as monitor key for standby mode.
5. (**FUNC Function key**) : as a multifunction key, such as a photo-taking key **[Photo]**, a time setting key, ringing setting key **[Ring]** and a delete setting key.
6. Switch key "ON/OFF" : as a power "ON/OFF" key, the screen would be light when short press it/ "unlock" key.
7. Volume key(+/-)

B. Outdoor unit keys

1. Doorbell key "Call" : ring the bell and trigger photo-taking there is no one on-hook.
2. Reset: match the communication code with the handset.

7

Installation Guide

Outdoor unit shall be installed at 1.4~1.7 meter above the floor, and the camera shall avoid facing the sunlight directly.

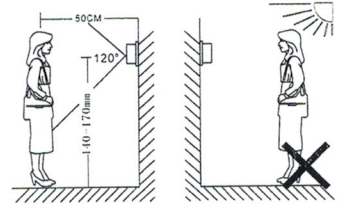

Installation Steps

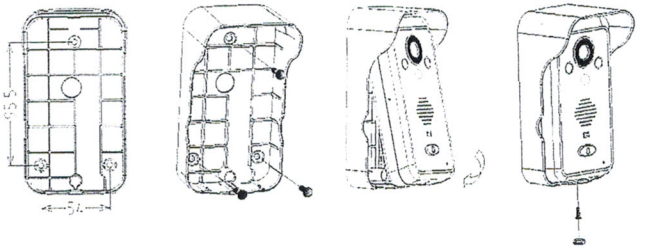

1. Drill a hole refer to the dimension, put the screw rubber plug in, then fix the rainproof cover on the wall by screws.
2. Connect the charging line according to the wiring diagram(the hole for wire getting through suggested 16~30mm), if charging line comes from indoor, lead the charging line pass through the hole, if charging line comes from outdoor, lead the charging line pass through the bottom of rainproof cover and connect the line.
3. Install rechargeable lithium battery (BP-6M) to outdoor unit, the unit starts up automatically.
4. Put the top part of outdoor unit into the rainproof cover like the picture, push the bottom part, make sure its steady and fix it from the bottom by screw, then fit on the screw cover.

8

Product Diagram

Outdoor unit:

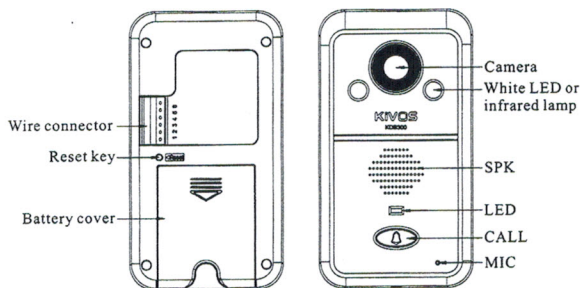

Indoor monitor:

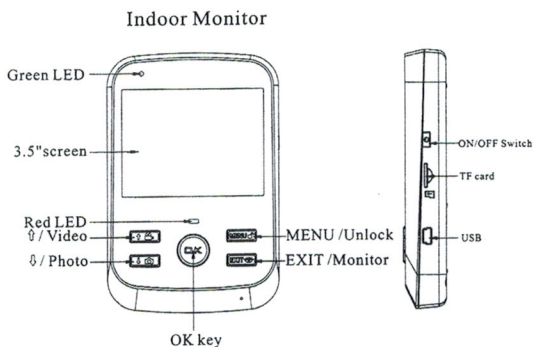

6

Wall-hung type holder and table type holder for Indoor monitor:

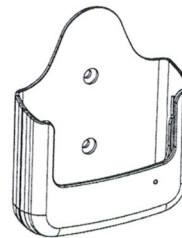

Wall-hung type holder

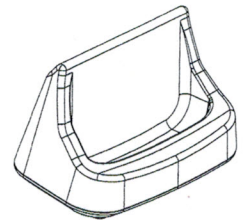

Table type holder

Key introduction

A. Indoor monitor Keys (6pcs Key):

1. "OK" key: one of the key to choose one-way or both-way talkback function.
2. "↑ UP/ [Video]" key: work as option key for MENU, as video key when calling or monitoring, as option key when calling extension monitor.
3. "↓ DOWN/ [Photo]" key: work as option key for MENU, as photo key when calling or monitoring, as entrance key for exposure adjust, as option key when calling extension monitor.
4. "EXIT/ [Monitor]" key: work as monitor key for standby mode, as exit key for MENU, one of the key to choose one-way or both-way talkback function.
5. "MENU/ [unlock]" key: work as unlock key when communicating with outdoor unit, as right moving key for time setting, MENU key for standby mode.
6. Switch key "ON/OFF" : work as infrared lamps switch while communicating, for exposure adjustment.

B. Outdoor unit keys

1. Doorbell key "Call" : ring the bell and trigger video taking when pressed.
2. Reset: erase the communication code.

7

Connection Diagram for Outdoor Unit

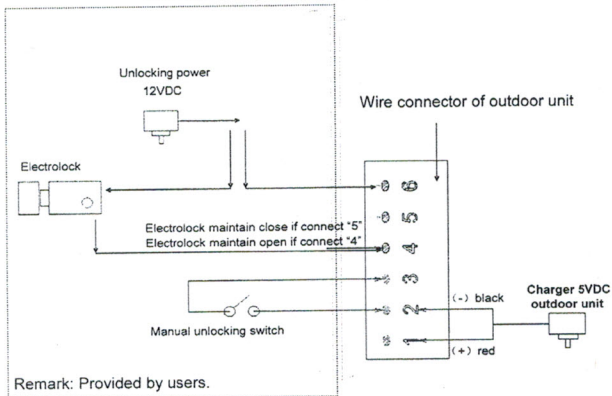

Attentions during Installation

1. The outdoor photosensitive sensor should not be hidden or blocked by other objects.
2. Do not face outdoor unit to sunlight directly.
3. Install the connection line correctly, otherwise, normal use shall be failure.

Battery Installation

1. Parallel move the battery cover downward, and take it off.
2. Insert the lithium battery along the battery jar and set it level, mind the front and reverse side of the battery.
3. Fit on the battery cover.

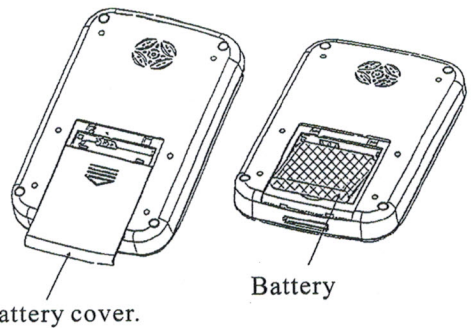

Functions and Applications

Outdoor Unit Starting Up

Connect to external power to start up. The power source is only battery, main MCU is woken about every one second. Sleep mode is in saving power mode.

Indoor Monitor Starting Up

Install battery to indoor monitor, long press ?Switch key? about 3 seconds to start up (about 1 second after shutdown), logo shall be displayed on screen with a sound of "Beep". Turn into standby mode.

- Display: standby picture, signal sign, power sign, time & date, ring and PIR(on)
- In this mode, the screen gets dark after several seconds and turn into power saving mode, the red LED flashes every 4 seconds. The screen would be lighted if press again.
- When battery is in low power (≤ 1 bar), red LED flashes every one second. It remains you to charge it.
- In standby mode, long press "Switch key" about 3 seconds to shut down.

Installation guide

Outdoor unit shall be installed at 1.4~1.7 meter above the floor, and the camera shall avoid facing the sunlight directly.

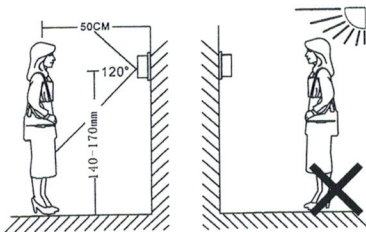

Installation steps

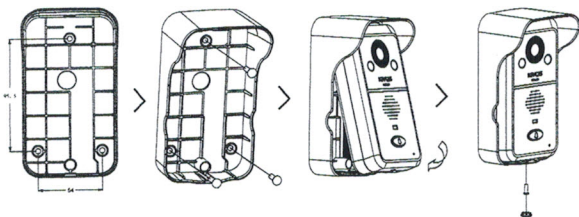

1. Drill a hole refer to the dimension, put the screw rubber plug in, then fix the rainproof cover on the wall by screws.
2. Connect the charging line according to the wiring diagram(the hole for wire getting through suggested 16~30mm), if charging line comes from indoor, lead the charging line pass through the hole, if charging line comes from outdoor, lead the charging line pass through the bottom of rainproof cover and connect the line.
3. Install rechargeable lithium battery(BP-6M) to outdoor unit, the unit starts up automatically.
4. Put the top part of outdoor unit into the rainproof cover like the picture, push the bottom part, make sure its steady and fix it from the bottom by screw, then fit on the screw cover.

Connection Diagram for Outdoor Unit

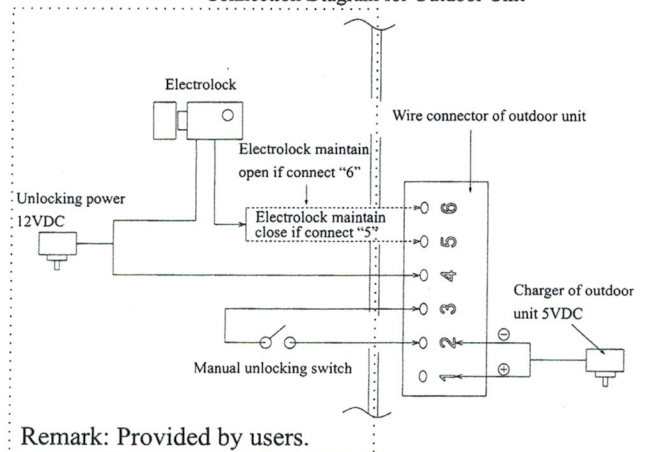

Unlocking Setting

1. Long press door bell until indicator blinks one time (approx 9 seconds, with a sound of "Beep"), loosen the key right now, unlocking time is set as 1.8 seconds (Default unlock setting).
2. Keep pressing until indicator blinks two times (approx 3seconds more, with two sound of "Beep"), loosen the key right now, unlocking time is set as 4 seconds.
3. Keep pressing until indicator blinks three times (approx 3 seconds more, with three sounds of "Beep"), loosen the key right now, unlocking time is set as 8 seconds.

Night-vision

With night-vision function, even under the environment of extremely poor visibility, the outdoor unit can activate infrared lamps and recognize clearly objects or people within the distance of 1.5meter (the best focus of this product is 0.8 meter). In addition, under complete black condition, it displays black and white effects.

! Note: Please keep the lens of infrared lamps clean.

Menu Setting

When the screen lights up, long press "FUNC" key, enter into menu setting. Then press "FUNC" key in sequence, it would respectively enter into "Time Setting" → "Ringing Setting" → "Lock Delay Setting" → "PIR Setting"

Date & Time setting

- Press "↑/↓" key to choose the figure of date& time.
- Press "+/-" key to adjust digit-size.
- Press "OK" key to affirm and turn back to standby condition.

Ringing Setting

- Press "↑/↓" key - choose the music you like (12 pieces in total)
- Press "+/-" key- increase or decrease the volume level (7 levels in total)
- Mute: long press "-" key still there is a mute symbol.
- Press "OK" key, confirm and back to standby condition

Lock Delay

- Press "↑" or "↓" key to adjust the time, the range of the time is 1~6 seconds.

11

Attentions During Installation

- 1.The outdoor photosensitive sensor should not be hidden or blocked by other objects.
- 2.Do not face outdoor unit to sunlight directly.
- 3.Do not stick label on the speaker, otherwise, the sound effect of doorbell will be affected.
- 4.Install the connection line correctly, otherwise, door phone disabled may be caused.

Battery Installation

- 1.Move the battery cover downward parallelly, and then take it off.
- 2.Insert the lithium battery along the battery jar and set it level, mind the front and reverse side of the battery.
- 3.Fit on the battery cover.

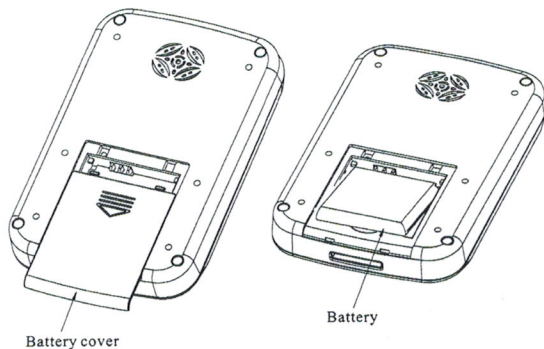

10

- Press "OK" key, confirm and back to standby condition.

Unlocking Explanation

Only in the state of intercom, press "ON/OFF Switch" to unlock with unlocking symbol showing on the screen.

PIR : ON/OFF

- Press "↑" or "↓" to choose "ON" or "OFF", the setting value shall be sent to outdoor camera by pressing "OK" key or "FUNC" key.

PIR Explanation

The PIR detects human being within its detection range, the signal shall be sent to indoor monitor to wake up the screen and activate photo snapping. After that, outdoor camera and indoor monitor would get into standby state.

When the screen is lit, press "OK" key to intercom

When the configuration is one camera and three indoor monitors, the PIR function could be switched on or off through menu of each indoor monitor. A red PIR symbol shall be shown on the top of the screen after switching on the PIR function. The other two indoor monitors shall show PIR state synchronously when communicating with outdoor camera.

When someone is getting into the detection range of PIR, only one of the indoor monitors would be woken up and takes photo.

After matching code, PIR would be switched off.

Outdoor unit CALL Indoor monitor

When the screen lights up

In standby mode, press "doorbell key" to call, the background light of the outdoor unit lights up with a sound of ?Du Du?. The screen of indoor monitor shows image and the unit rings for Max. 30 seconds. If there is no reply signal from indoor monitor, the outdoor unit stops the Call and recall is allowed.

- Intercom: press "OK" on indoor monitor -> ring stops and the

12

Installation of storage card

- 1.Insert the storage card in the way as shown in the diagram until you hear a clicking sound
- 2.Improper insertion of storage card may cause system failure, please confirm the inserting direction of the card.
- 3.Take out of the storage card — push in the storage card until you hear a clicking sound, then the storage card will pop up

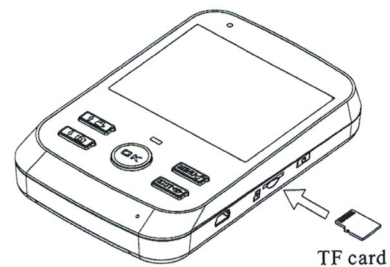

Storage Card Introduction

- This product adopts T-flash card as external storage device, when there is no storage card in the product, the photo-taking and video-recording functions are unrealizable.
- If a self-provided storage card is used:
 - Please use a storage card with Class 4 or above.
 - Up to 4G storage card supported.
 - This machine has automatic cyclic storage function, when the storage card is full, the original file will be overwritten.
 - his machine can connect to computer by USB line. Or take out the T-flash card and connect to computer by card reader. ! Attention: do not distort, extrude or strike the storage card, otherwise, the audio-video material recorded on it may be damaged.

11

unit turns into intercom mode, intercom time is Max. 90seconds.

- Photo: in "OK" on-state mode -> press "FUNC" function key -> press photo-taking "📷" key -> one press one photo.
- Exit: in "OK" on-state mode -> press "OK" key (in monitor mode -> press "Exit") the unit turns into standby mode with a sound of "Beep".
- Automatic photo shoot: if nobody answers the call in 5 seconds, indoor monitor starts taking photos automatically.

Indoor monitor CALL Outdoor Unit (Monitoring)

In standby mode, press "👁️" monitor key on handset to monitor call. If outdoor unit receives signal in 5 seconds, then it connects with outdoor unit, handset turns into normal monitor mode and shows image and speaks voice of outside. There is no voice from outdoor unit, it will be in monitoring. If the handset doesn't receive signal in 5 seconds, it turns back to standby mode automatically.

- Intercom: in monitor mode, there is voice from handset but not from outdoor unit -> press "OK" to turn into both-way communication -> . Intercom time is 90 seconds .
- Photo: in monitor mode -> press photo-taking "📷" of "FUNC" function key -> one press one photo.
- End1: in monitor mode -> press "👁️" monitor key -> end monitor and turn back to standby mode.
- End2: in intercom mode, press "OK" to hang off and turn back to standby mode.

Exposure Adjustment

Exposure adjustment: under the environment of extremely poor visibility and the image is not clear due to the brightness, however, the brightness is adjustable: 9 grades for exposure adjustment.

- In image communication mode -> long press "↑/↓" to adjust the grade of exposure, every press adjusts one grade.

13

Photo Preview & Delete

When the screen lights up

- Preview: long press "↓ [📷] / preview key", display the latest pictures which are ranked by time, the latest one is on the top list.
- Check: press "↑ up" key, check previous photo -> press "↓ down key", check the next photo.
- Delete: press "Delete" of "FUNC" -> press "↑ Up" or "↓ Down" key to select "yes" or "No" -> press "OK" to confirm.
- Exit: finish the operation, press "OK" key to exit photo preview.

Match code setting

- Handset is in shutdown mode -> long press power button -> "Welcome" would be displayed on the screen -> please immediately click the power button -> screen would be displayed "Pairing";
- Meanwhile, click "Reset" key of outdoor unit -> blue lamp flashes and then match the code.
- If there is image on handset, code match succeeded; otherwise, match the code again.
- When there are 2 or 3 sets of Indoor monitor finished matching code, please call once again by outdoor unit. If these handsets are displaying at the same time, it succeed.

Note: a launcher could max. support 3 handsets. If you match the code forth time, it would delete the previous three codes.

Battery and Charge

- Be sure the activity of the battery, please fully charged the new battery.
- A small battery symbol shall be shown on the top of the screen when the outdoor unit connect with indoor monitor.

14

Functions and Applications

Outdoor Unit Starting Up

Connect to external power to start up. If the power source is only battery, main MCU is woken about every one second. Sleep mode saves power (Monitor and alarm functions could be realized in both two power supply conditions.). When external power and battery supply power simultaneously, the effect is same to external power supports the unit only, when battery is in low power, the external power will charge the battery automatically, green LED flashes every one second, it recovers to its previous state when the battery is full.

Indoor Monitor Starting Up

Install battery to indoor monitor, long press "Switch key" about 3 seconds to start up (about 1 second after shutdown), logo shall be displayed on screen with a sound of "Beep". Turn into standby mode.

- Display: standby picture, unit ID, signal sign, power sign, time & date
- Red LED flashes every 4 seconds. When battery is being charged, the red LED flashes every one second. When battery is in low power (≤ 1 bar), red LED flashes every one second.
- In this mode, the screen shall be dimmed after some seconds and turns into power saving mode.
- If there is any calling record under this mode, red LED flashes every 1 second and stops flashing after checking.
- In standby mode, long press "Switch key" about 3 seconds, "Goodbye" shall be displayed on screen with a sound of "Beep", the unit switches off.

12

Outdoor Unit Call Indoor Monitor

In standby time mode, press "Door bell key" to call, the green LED of the outdoor unit lights up with a sound of "Du Du". Red LED of indoor monitor lights up, the screen shows image and the unit rings for Max. 30 seconds. If there is no reply signal from indoor monitor, the outdoor unit stops the Call and recall is allowed.

- Intercom: press "OK" on indoor monitor -> ring stop and the unit turns into intercom mode, red LED of indoor monitor is off as well as green LED is on, intercom time is Max. 90seconds.
- Monitor: press "👁️" monitor key on indoor monitor -> red LED lights up, monitor outdoor voice without being discovered by the visitors. (One or both way intercom could be changed over by pressing "👁️" and "OK", and it will time again till 90seconds.).
- Unlock: in "OK" on-state mode -> press "🔓" unlock key -> after successful unlocking, it shows unlock icon.
- Photo: in "OK" on-state mode -> press "📷" photo taking key -> one press one photo, the photos will be stored in TF card.
- Video: in "OK" on-state mode -> press "📹" video taking key -> start taking video -> press "📹" video taking key again to stop, the videos will be stored in TF card.
- Exit: in "OK" on-state mode -> press "OK" key (in monitor mode -> press "Exit") the unit turns into standby mode with a sound of "Beep".
- Automatic video: if nobody answers the call in 5 seconds, indoor monitor starts taking video automatically (Default is automatic video. If setting is manual video, once connected, the indoor unit will take video manually) till being stopped or max. taking time.

Indoor Monitor CALL Outdoor Unit (Monitoring)

In standby mode, press "👁️" monitor key on indoor monitor to monitor call. In this mode, the red LED lights up. If outdoor unit receives signal in 5 seconds, then it connects to indoor monitor, indoor machine turns into normal monitor mode and shows image and speaks voice of outside. There is no voice speaking for outdoor unit. If outdoor unit does not receive signal in 5 seconds, then it shows "User not online" and exits monitor calling mode automatically and turns into standby mode.

Two sets of outdoor units (Code connected successfully): Press "👁️" monitor key on indoor monitor to turn into monitor selection menu -> press "↑/↓" key to

13

- The battery of outdoor unit can be changed or charged by charger.
- When the Indoor monitor is at low power (\leq a bar), the red indicator lamp will flash every second, please charge immediately
- The Indoor monitor can be charged by the table type holder or by USB, green light keeps bright.
- Charge-and-work supported. When the battery is charged fully, it auto stops charging.
- Battery type: high-quality lithium battery, please use the BP-6M model battery if it needs replacement
- Charging and battery attentions, please reference the chapter "Warm's and attentions" in this manual

Notice: Under the low power, display, photo-taking functions can't work normally.

Configuration

Manual	1piece
Outdoor unit	1piece
Indoor monitor	1~3 pieces
Table type holder of handset	1piece
Charger (DC5V)	1pieces
Lithium battery (BP-6M)	2~4pieces
Screw M4	1piece

Statement

This product maximum supports 1outdoor units to 3 Indoor monitor .The door phone has finished code match and can be used directly.

If you need more pieces of indoor monitors or outdoor units, please contact your local distributors .

15

choose code of outdoor units -> press "OK" to turn into monitoring call mode, red LED lights up (During selection, press "Exit" to turn into standby mode).

- Intercom: in monitor mode, red LED lights up, there is voice speaking for indoor monitor but not for outdoor unit -> press "OK" to turn into both-way communication, red LED shuts down -> press "☺" monitor key again to turn back to one way voice monitor mode. (One or both-way voice could be changed over repeatedly). Intercom time is 90seconds and shall be timed again after changing over.
- Unlock: in "OK" on-state mode -> press "🔑" unlock key -> after successful unlocking, it shows unlock icon.
- Photo: in monitor mode -> press "📷" photo taking key -> one press one photo, the photos will be stored in TF card.
- Video: in monitor mode -> press "📹" video taking key -> start taking video -> press "📹" video taking key again to stop, the videos will be stored in TF card.
- End: in monitor mode -> press "EXIT" key -> end monitor and turn back to standby mode. (In intercom mode, press "OK" to hang off.)

Note: in monitor mode, red LED lights up, in intercom mode, red LED shuts down.

Indoor Monitor CALL Indoor Monitor (Intercom)

(Only can realize when there are 2 and more indoor monitors.)

In standby mode, if there are only two indoor monitors in system, press "OK" to call another indoor monitor.

In standby mode, if there are three indoor monitors in system, press "↑" to call small code indoor monitor; press "↓" to call large code indoor monitor;

- If the CALLED indoor monitor does not receive the signal in 4 seconds, the CALL monitor shows "User not online", it turns back to standby mode with a sound of "Beep".
- If the CALLED indoor monitor receives the signal, two monitors play music, green LED lights up.
- If the CALLED indoor monitor does not reply, the monitors turn into standby mode after 30seconds.
- If the CALLED indoor monitor replies by pressing "Ok", music stops, red LED shuts down, green LED lights up to both of the monitors, and both monitors turn

14

General faults and solutions

Fault	Cause(s)	Solution(s)
Can not start up	Neglected to press switch button	Press switch button
	Lithium battery is not installed	Install lithium battery
	Low battery	Charge up lithium battery
	No connection to power adapter when battery runs out	Connect to power adapter
Can not charge	Adapter connector doesn't connect to charging port of machine correctly	Reconnect correctly
	Adapter doesn't connect to 110V--240V alternating current	Plug into the socket to connect to alternating current
Outdoor unit cannot call or connect to Indoor monitor	Code match failed	Clear code, and re-match code
Image has noisy point or flickers	Handset is placed near to TV player, microwave oven, daylight lamp or mobile phone which produces electromagnetic wave interference.	Keep handset far away from the interference items
No signal for Indoor monitor	Outdoor unit doesn't connect to the power	Connect to the power
	Distance between outdoor unit and Indoor monitor is too far	Adjust to appropriate distance
	Disturbed by magnetic field around	Keep handset far away from magnetic field

16

into intercom mode, communication time is max. 90seconds.

- The CALL indoor monitor has initiative hang up function.
- During communication, if any end in the communication presses "OK", then both two ends hang up with a sound of "Beep" and turn to standby mode.

Night-vision

With night-vision function, even under the environment of extremely poor visibility, the indoor monitor can activate infrared lamps and take photo or video of the objects or people within the distance of 1.5meter.

- * If white LED configured, the screen displays in color.
- * If Infrared lamp configured, the screen displays in black and white.
- Under connection condition of outdoor unit and indoor monitor, press "ON/OFF" key to activate infrared lamps on outdoor unit.
- Press "ON/OFF" key again to shut down infrared lamps.

! Note: Please keep the lens of infrared lamps clean.

Exposure Adjustment

6 grades for exposure adjustment: (Expo: 00-05)

- In image communication mode -> long press "↓" about 1 second -> (the screen displays grade prompt information) turn into exposure adjustment function.
- Press "ON/OFF" key to adjust exposure, every press adjusts one grade. Remark: Grade 00: automatic exposure; grade 01-05: manual exposure. Adjust circularly and save automatically.

Tamper Alarm Function

It shall alarm if outdoor unit is detached from the shell.

The indoor monitors shall alarm as well as display image once the outdoor unit alarms, and the indoor monitors shall produce an alarm file. The indoor monitors alarms for max. 2minutes.

Press "OK" key to stop alarm;

! Note: The outdoor unit only could work when it is repowered on and reinstalled into the shell.

15

FC Changes or modifications not expressly approved by the party responsible for compliance could void the user's authority to operate the equipment. This equipment has been tested and found to comply with the limits for a Class B digital device, pursuant to Part 15 of the FCC Rules. These limits are designed to provide reasonable protection against harmful interference in a residential installation. This equipment generates uses and can radiate radio frequency energy and, if not installed and used in accordance with the instructions, may cause harmful interference to radio communications. However, there is no guarantee that interference will not occur in a particular installation. If this equipment does cause harmful interference to radio or television reception, which can be determined by turning the equipment off and on, the user is encouraged to try to correct the interference by one or more of the following measures:

- Reorient or relocate the receiving antenna.
- Increase the separation between the equipment and receiver.
- Connect the equipment into an outlet on a circuit different from that to which the receiver is connected.
- Consult the dealer or an experienced radio/TV technician for help.

CE FC  301

USB Function Description

In standby mode, with TF card in the monitor, plug in USB wire, the screen shall display a selection menu: "USB", "POWER"

- Choose "POWER" by pressing "↑/↓", the USB only serves as charging function, the indoor monitor works as normal.
- Choose "USB" by pressing "↑/↓", connect the monitor with the computer and read the files through computer.

Indoor Monitor Menus

- In standby mode, press "MENE" to turn into main menu.
- 6 submenus: "Video", "Photo", "Setting", "Code", "Call History", "Exit" are under the main menu.
- Choose submenu by pressing "↑/↓", press "OK" to confirm.

Remark: Turn back to previous menu by pressing "EXIT" in submanu, turn back to standby mode by pressing "EXIT" in main menu.

Video

Turn into video menu and operate.

- If there is no TF card, screen displays "No SD Card" and turns back to main menu.
- If there is TF card but no video record, screen displays "No File!" and turns back to main menu.
- If there is TF card and video record, screen displays video list by time order, newest file is listed on the top.
- Choose operating command "Play", "Delete", "Delete All" or "Back" by pressing "↑/↓" -> press "OK" to turn into operating.
- In Play mode -> press "OK" to pause and play -> press "EXIT" to exit.
- After operation, exit automatically or by pressing "EXIT" to turn back to video operation menu.

Photo

Turn into photo menu and operate.

- If there is no TF card, screen displays "No SD Card" and turns back to main menu.
- If there is TF card but no photo record, screen displays "No File!" and turns back to main menu.
- If there is TF card and photo records, screen displays photo list by time order, newest file is listed on the top.
- Choose operating command "View", "Set As Background", "Delete", "Delete All" or "Back" by pressing "↑/↓" -> press "OK" to turn into operating.
- In View mode -> press "↑" to view the last photo, press "↓" to view the next photo
- After operation, press "EXIT" to turn back to photo operation menu.

Call History

Turn into "Call History" to check call history (Green LED flashes every 1 second if there is missed call).

- If there is no call history, screen displays "No Record".
- Choose operating command "Play" or "Delete" by pressing "↑/↓", press "OK" to turn into operating
- If there is no TF card, choose command "Play", the screen displays "No Video File!" and turns back to Call History menu.
- In Play mode -> press "Ok" to pause and play -> press "EXIT" to exit
- When choose "Play" and if there is not TF card, screen displays "No Video File!" and turns back to Call History Menu.
- In Play mode -> press "OK" to pause and play -> press "EXIT" to exit.
- After operation, press "EXIT" to turn back to call history operation menu.

! Note: Unplug the power and reset, all the call history will disappear.

FC Changes or modifications not expressly approved by the party responsible for compliance could void the user's authority to operate the equipment. This equipment has been tested and found to comply with the limits for a Class B digital device, pursuant to Part 15 of the FCC Rules. These limits are designed to provide reasonable protection against harmful interference in a residential installation. This equipment generates uses and can radiate radio frequency energy and, if not installed and used in accordance with the instructions, may cause harmful interference to radio communications. However, there is no guarantee that interference will not occur in a particular installation. If this equipment does cause harmful interference to radio or television reception, which can be determined by turning the equipment off and on, the user is encouraged to try to correct the interference by one or more of the following measures:

- Reorient or relocate the receiving antenna.
- Increase the separation between the equipment and receiver.
- Connect the equipment into an outlet on a circuit different from that to which the receiver is connected.
- Consult the dealer or an experienced radio/TV technician for help.



Code

Enter the Code Menu, input password (0000). If the password is wrong, screen shows "Password error!", "Please input again!", please input the right password.
Match code function: match code; give code; receive code; inform:

- **Match code** (Outdoor unit should connect to the Indoor monitor)
 - Select "Match Code" on indoor monitor -> press "OK" key-> enter into the match code mode
 - Under the standby mode of outdoor unit -> long press "call" key-> loosen key until the sound of a "Beep", enter into the match code mode
 - If two units match successfully in 16 seconds, indoor monitor displays "Success", outdoor unit makes "Beep-Beep-Beep" sounds, as the first outdoor unit
 - If matching failed in 16 seconds, indoor monitor shows "failed", the outdoor unit makes "Beep" sound
 - Press "EXIT" key on the indoor monitor, exit menu, enter into the standby mode

Notice: If failed match, rematch the code after connection, otherwise, rematch the code after clear the code

1. Indoor monitor clear code method: refer to the menu function -> code -> clear code.
2. Outdoor unit clear code method:
 - A. Transformer supply: long press "Clear Code" key about one second, code cleared after a "tick" sound.
 - B. Battery supply: press "Clear Code" key and "doorbell key" at the same time till a "Beep", code cleared.

- **Give code & Receive code** (match more indoor monitors and outdoor units):
 - Choose "give code" on indoor monitor given or received code-> press "OK" key-> enter into "give code" mode
 - Added indoor monitor enters into the code menu as above steps-> choose "receive code" -> press "OK" key-> enter into the receive code mode.
 - If code receiving finished in 16 seconds, exit code receiving mode after three "beep" sounds, and then enter into code menu.
 - The added outdoor unit(finished clear code), under the standby mode-> keep pressing "call" key for 6 seconds until two "beep" sounds("beep" once

about 3 seconds) -> loosen the key to enter into code receiving mode.

- Outdoor unit make three "beep" sounds if receive code successfully, and as No. 2 outdoor unit.
- If failed to receive code in 16 seconds, exit receive code mode after one "beep" sound. Enter into the Code Menu (Outdoor unit enters into the standby mode)
- After code receiving finished, press "OK" key on code give unit to exit the code give mode, enter into the code menu.
- Press "EXIT" key to return to MENU gradually, then enter into standby mode
- After all units receive code finished, please use the No. 2 outdoor unit call all indoor monitors, if all code matched, receive code successfully; if not, clear code of the new unit (do not clear the code giving unit), reform the code giving and code receiving again.

Notice:

1. Please do not set same ID number for every indoor monitors and outdoor units.
2. The original Password for code match menu is "0000".
3. Inform function: after match code, give code, receive code, clear code and reset ID number, please inform. Inform: tell all units the pieces and ID numbers in the system.
4. Method of inform: outdoor unit calls all the indoor monitors (all indoor monitors should be matched), if there are two outdoor units, use the No. 2 outdoor unit to inform.

•Clear Code

Choose "code" option, press "OK" key to enter into password menu.

- Input the password to enter into code match menu (original password is 0000). If you input wrong password, system will inform you "Password Error!", "Please Input Again!", enter into the code match menu until input the right password
- Press "↑/↓" key -> choose "Clear Code" -> press "OK" key, enter into clear code menu.
- Press "↑/↓" key -> choose "Clear" (press "Back" to exit if you do not want to clear anything), system will return to code menu automatically after code clear confirmed

FC Changes or modifications not expressly approved by the party responsible for compliance could void the user's authority to operate the equipment. This equipment has been tested and found to comply with the limits for a Class B digital device, pursuant to Part 15 of the FCC Rules. These limits are designed to provide reasonable protection against harmful interference in a residential installation. This equipment generates uses and can radiate radio frequency energy and, if not installed and used in accordance with the instructions, may cause harmful interference to radio communications. However, there is no guarantee that interference will not occur in a particular installation. If this equipment does cause harmful interference to radio or television reception, which can be determined by turning the equipment off and on, the user is encouraged to try to correct the interference by one or more of the following measures:

- Reorient or relocate the receiving antenna.
- Increase the separation between the equipment and receiver.
- Connect the equipment into an outlet on a circuit different from that to which the receiver is connected.
- Consult the dealer or an experienced radio/TV technician for help.



Setting

Enter into Setting, press "↑/↓" key choose the submenu, press "OK" key into corresponding submenu.

- Music Setup
- Brightness
- Own ID Number
- Auto Control
- Backlight Time
- Volume Setup
- Date Setup
- Security Password
- Music Volume
- Restore Wallpaper
- Version
- Delete Alarm Notice

- Music Setup Enter into "Music Setup" for music choosing menu.
 - Press "↑/↓" key -> to music you like(12 pieces in total) -> press "OK" key to listen.
 - Press "OK" key again or press "EXIT" key to set the music as ringing, exit Musit Setup
 - Press "EXIT" key to enter into the standby mode.

- Brightness Enter into "Brightness" menu and adjust the brightness.
 - Press "↑/↓"key-> increase or decrease the brightness level(6 levels in total)-> press "OK" key-> set the brightness level -> exit the setup menu
 - Press "EXIT" key to turn back to standby mode

Notice:

6 levels for brightness setup (only could be set up in menu). If level reaches to the highest, pressing "↑" key is useless, to the lowest, pressing "↓" key is useless.

- Own ID Number Enter into Own ID Number to set up ID.
 - Press "↑/↓" key -> set up ID number -> press "OK" key -> confirm and exit ID Number setup menu
 - Press "EXIT" key to turn back to standby mode step by step.

Notice: Please do not repeat ID number for every indoor monitors and outdoor units.

- Auto Control Enter into "Auto Control" to set up video.
 - Press "↑/↓" key -> set up "Auto video" or "Manual video" -> press "OK" key to confirm and exit. Default setting is auto video (with SD card) and manual photo.
 - Press "EXIT" key to turn back to standby mode step by step.

Notice:

Auto video: If nobody replies in 5 seconds after connection, the indoor monitor starts up auto video (Factory default is auto video, if manual video is set, video recorded after calling) till being stopped or max. record time.

- Backlight Time Enter into Backlight Time menu to set up standby time, exit menu automatically after setup.

- Press "↑/↓" key-> increase and reduce standby time(10s-60s) -> press "OK" key to setup and return to Backlight Time Setup menu.
- Press "EXIT" key to enter into the standby mode.

- Volume Setup Enter into Volume Setup menu.

- Press "↑/↓" key -> increase and reduce volume(8 levels in total) -> press "OK" key to set up and return to Volume Setup menu .
- Press "EXIT" key to enter into the standby mode.

Notice: 8 levels for volume (only could be set up in menu).

- Date Setup Enter into Date Setup menu.

- Press "MENU" key to choose figure of time or date.
- Press "↑/↓" key to adjust the figure
- Press "OK" key to set up and return to Date Setup menu
- Choose "Show", set "Y", date will show. Set "N", date will not show
- Press "EXIT" key to enter into the standby mode

- Security Password Enter into Security Password menu.

- Press "MENU" key to choose figure of old or new password.
- Press "↑/↓" key -> adjust figure -> press "OK" key to set up
- If original password is right, screen shows "success!", and then return to the setup menu.
- If original password is wrong, screen shows "failed", and then return to code match menu, please set up again
- Press "EXIT" key to turn back to standby mode.

FC Changes or modifications not expressly approved by the party responsible for compliance could void the user's authority to operate the equipment. This equipment has been tested and found to comply with the limits for a Class B digital device, pursuant to Part 15 of the FCC Rules. These limits are designed to provide reasonable protection against harmful interference in a residential installation. This equipment generates uses and can radiate radio frequency energy and, if not installed and used in accordance with the instructions, may cause harmful interference to radio communications. However, there is no guarantee that interference will not occur in a particular installation. If this equipment does cause harmful interference to radio or television reception, which can be determined by turning the equipment off and on, the user is encouraged to try to correct the interference by one or more of the following measures:

- Reorient or relocate the receiving antenna.
- Increase the separation between the equipment and receiver.
- Connect the equipment into an outlet on a circuit different from that to which the receiver is connected.
- Consult the dealer or an experienced radio/TV technician for help.



- Music Volume Enter into Music Volume menu and press "OK" key to enter into Music Volume menu, music rings.
 - Press "↑/↓" key -> increase and reduce volume(4 levels in total) -> press "OK" key to set up and return to Volume Setup menu.
 - Press "EXIT" key to turn back to standby mode
- Restore Wallpaper Enter into Restore Wallpaper menu.
 - Press "OK" key to restore wallpaper, after displaying the restore wallpaper, return to Setup Menu
 - Press "EXIT" key to turn back to standby mode step by step
- Version Enter into Version menu.
 - Press "OK" key to view version, return to setup menu automatically in 2 seconds
 - Press "EXIT" key to turn back to standby mode step by step
- Delete Alarm Notice Enter into Delete Alarm Notice
 - Press "OK" key to delete alarm notice. Screen shows "Success!" and then return to setup menu
 - Press "EXIT" key to turn back to the standby mode step by step.

Battery and Charge

- Under the connection mode, when the outdoor unit is at low power, the indoor monitor will show "out low power" to remind you to charge for outdoor unit
- When the indoor monitor is at low power (\leq a bar), the red indicator lamp will flash every second, please charge immediately
- This product can be charged by charger or by USB data line connected to computer, or remove the lithium battery, charge by the universal charger, support working while charging
- Battery type: this product with high-quality battery, if change, please use the BP-6M model battery
- Charging and battery attentions, please reference the chapter "Warns and attentions" in this manual

Notice:

Under the low power, video-recording, photo-taking and card reader function can not work normally.

Configuration

- Manual 1piece
- Waterproof case 1piece
- Outdoor unit 1piece
- Indoor monitor 1piece
- Wall hung holder 1piece
- Indoor monitor holder 1piece
- Charger (DC5V) 2pieces
- USB data line 1piece
- Lithium battery (BP-6M) 2piece
- Screw M3 2pieces
- Screws for waterproof case 5pairs

Statement

The standard configuration for KiVOS door phone is one indoor monitor and one outdoor unit. The door phone has finished code match and can be used directly.

If you need more pieces of indoor monitors or outdoor units, please contact your local distributors (Maximum 2 outdoor units to 3 indoor monitors supported). For the added units, please reference the Give Code and Receive Code in the Code Menu.

FC Changes or modifications not expressly approved by the party responsible for compliance could void the user's authority to operate the equipment. This equipment has been tested and found to comply with the limits for a Class B digital device, pursuant to Part 15 of the FCC Rules. These limits are designed to provide reasonable protection against harmful interference in a residential installation. This equipment generates uses and can radiate radio frequency energy and, if not installed and used in accordance with the instructions, may cause harmful interference to radio communications. However, there is no guarantee that interference will not occur in a particular installation. If this equipment does cause harmful interference to radio or television reception, which can be determined by turning the equipment off and on, the user is encouraged to try to correct the interference by one or more of the following measures:

- Reorient or relocate the receiving antenna.
- Increase the separation between the equipment and receiver.
- Connect the equipment into an outlet on a circuit different from that to which the receiver is connected.
- Consult the dealer or an experienced radio/TV technician for help.

CE FC  301



CE

FC

ID:Q3XKDB300
ID:Q3XKDB300-1

- Producer: KIVOS HK INDUSTRY LIMITED.
- Manufacturer: Shen Zhen Hong Ji Electronics Technology Co.,Ltd.
Address: Building 3rd/4th, No. 6 Industrial Park, Yulv Village, Gongming
Town, Guangming New District, Shenzhen, China.
Tel: 0755-27150838 27150848
[http: www.kivos.com.cn](http://www.kivos.com.cn)